



US00D941253S

(12) **United States Design Patent**
Wirth et al.

(10) **Patent No.:** **US D941,253 S**

(45) **Date of Patent:** **** Jan. 18, 2022**

(54) **TRAILER-LIGHT PLUG COVER**

D664,099 S * 7/2012 Fukushima D13/156
D762,589 S * 8/2016 Sanfleben B60D 1/58
D13/156
D765,606 S * 9/2016 Hack D13/156

(71) Applicant: **WirthCo Engineering, Inc.**,
Minneapolis, MN (US)

(72) Inventors: **Andrew W. Wirth**, Minneapolis, MN
(US); **Kelly T. Eagan**, Minneapolis,
MN (US)

(73) Assignee: **WirthCo Engineering, Inc.**,
Minneapolis, MN (US)

(**) Term: **15 Years**

(21) Appl. No.: **29/655,505**

(22) Filed: **Jul. 3, 2018**

(51) **LOC (13) Cl.** **13-03**

(52) **U.S. Cl.**

USPC **D13/156**

(58) **Field of Classification Search**

USPC D13/110, 156, 133, 155, 184, 154, 162,
D13/152, 118, 120

CPC H01R 13/41; H01R 13/52; H02G 3/086;
Y10T 16/46; B60D 1/605

See application file for complete search history.

(56) **References Cited**

U.S. PATENT DOCUMENTS

5,722,854 A * 3/1998 Geisler B60D 1/62
439/148
D448,351 S * 9/2001 Dubose D13/156
7,771,221 B1 * 8/2010 Blackwell H01R 13/52
439/282
D629,366 S * 12/2010 Ericson D13/156

OTHER PUBLICATIONS

Wirthco.com. "7-Way Trailer Plug Cover." Date retrieved: May 2021. Date Published: Aug. 2020. <<https://www.wirthco.com/7-waytrailerplugcover.html>> (Year: 2020).*

* cited by examiner

Primary Examiner — Jennifer O King

(74) *Attorney, Agent, or Firm* — Charles A. Lemaire;
Jonathan M. Rixen; Lemaire Patent Law Firm, P.L.L.C.

(57) **CLAIM**

The ornamental design for a trailer-light plug cover, as shown and described.

DESCRIPTION

FIG. 1 is a left-side perspective view of a trailer-light plug cover showing the new design;
FIG. 2 is a right-side perspective view thereof;
FIG. 3 is a bottom perspective view thereof;
FIG. 4 is a top perspective view thereof;
FIG. 5 is a front perspective view thereof;
FIG. 6 is a back perspective thereof;
FIG. 7 is a side-front perspective view thereof; and,
FIG. 8 is a side-bottom perspective view thereof.

1 Claim, 3 Drawing Sheets

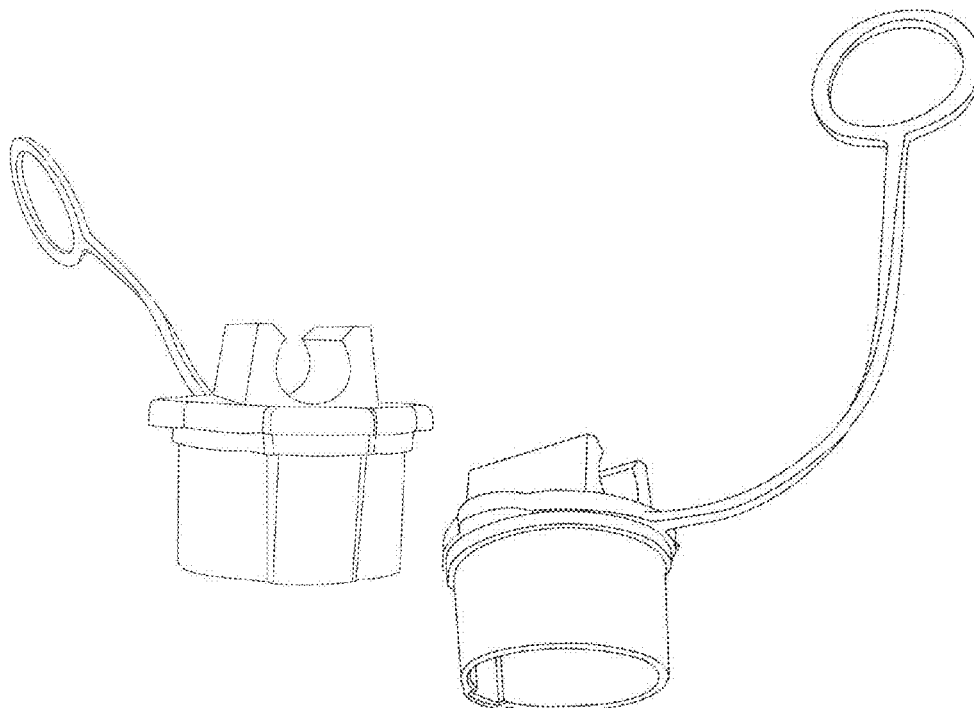

FIG. 1

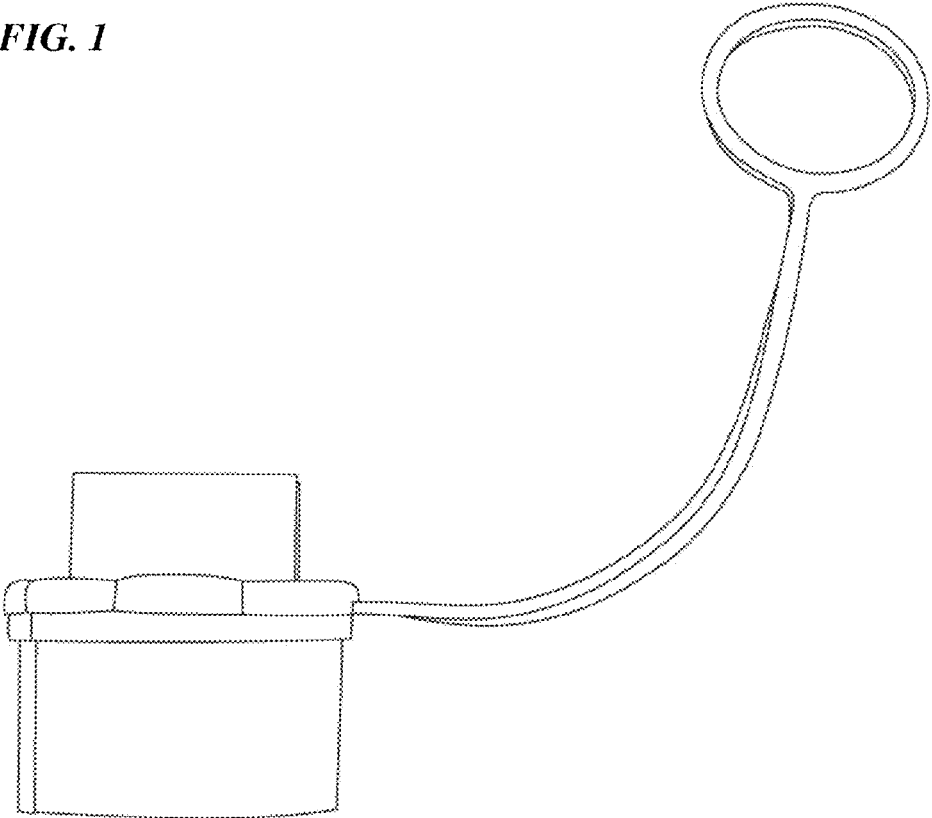

FIG. 2

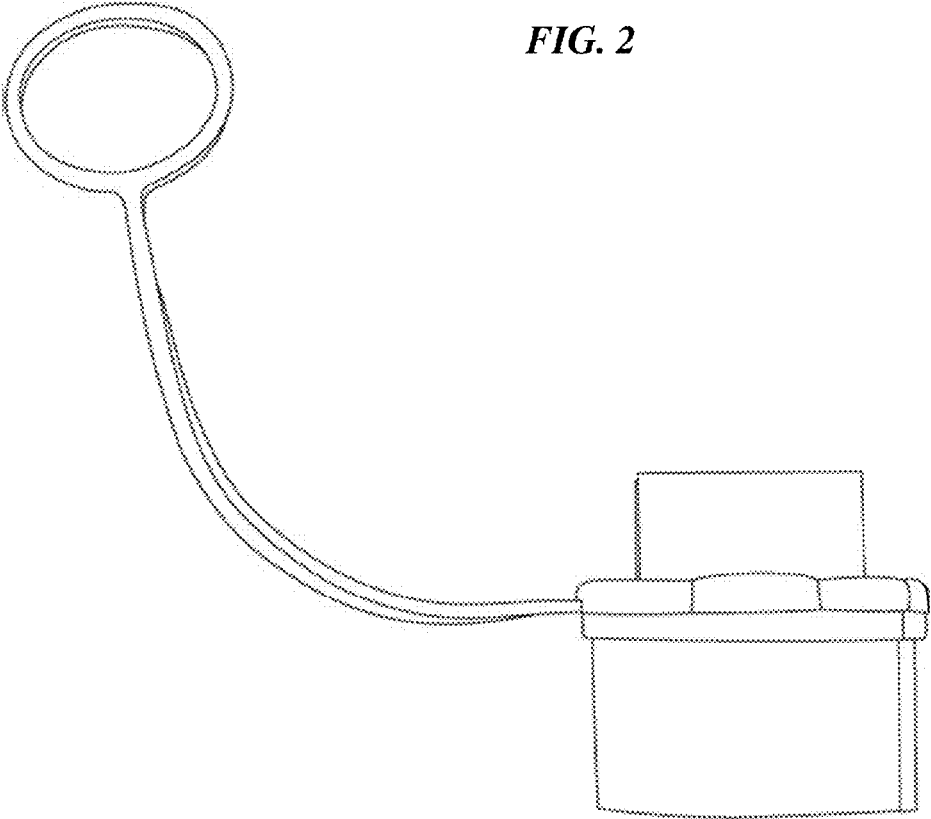

FIG. 3

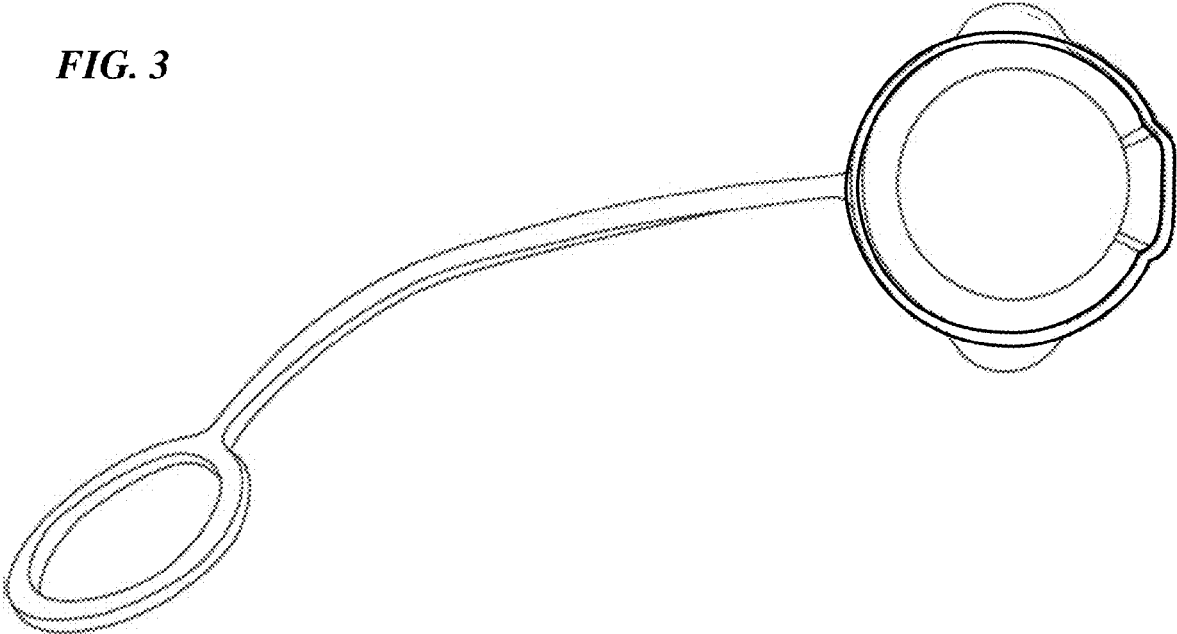

FIG. 4

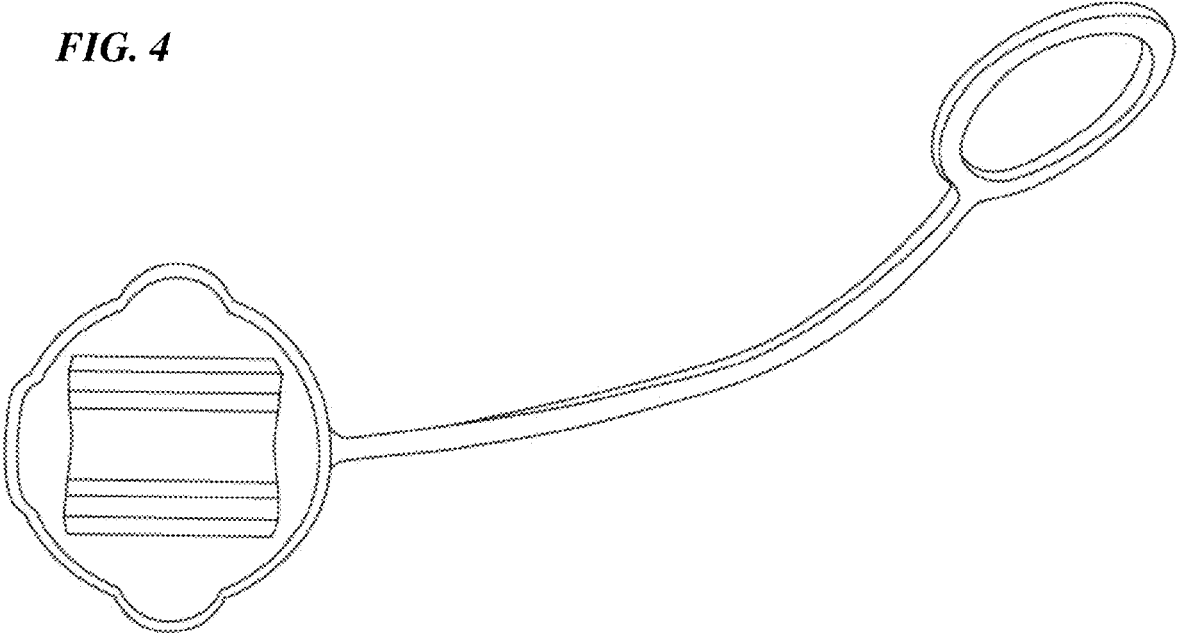

FIG. 5

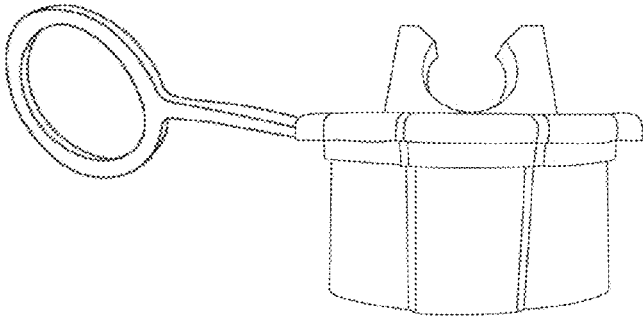

FIG. 6

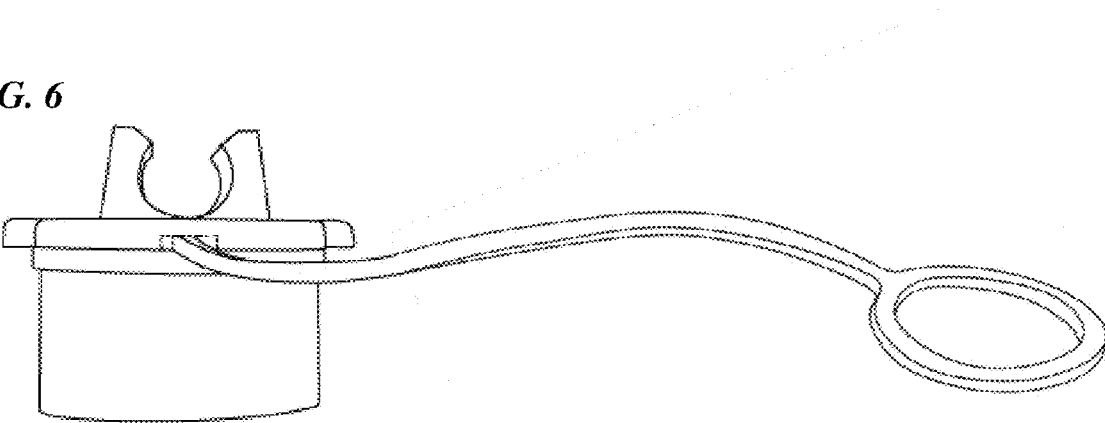

FIG. 7

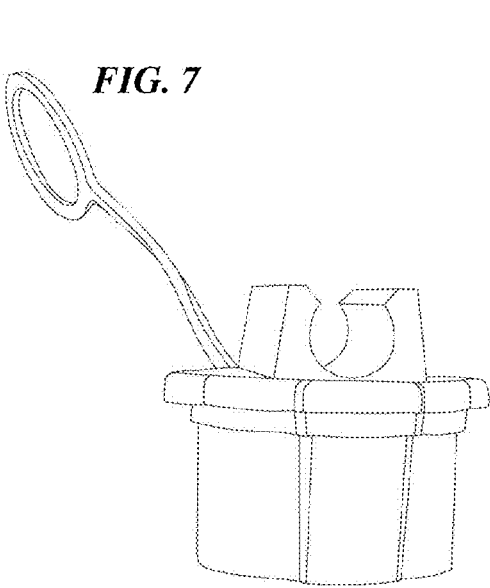

FIG. 8

